



Report No.: 161008077GZU-001
Issued: 2016-11-29

TEST REPORT

Applicant Name & Address : Shenzhen SOFARSOLAR Co., Ltd.
5L,Fourth Building,Antongda Industrial Park,Liuxian Avenue No.1,Xinan Street,Baoan District,Shenzhen,China.

Manufacturing Site : Same as above

Sample Description
Product : AC-coupled Storage Converter
Model No. : ME 3000SP
Electrical Rating : Battery Type: Lead-acid, Lithium-ion, Battery Voltage Range: 42-58Vdc
Max. Charging Current: 60A, Max. Discharging Current: 60A
Max. Charging & Discharging Power: 3000VA
Nominal Grid Voltage: 230Vac, Nominal output Voltage (stand-alone): 230Vac, Max. output Current: 13A, Nominal Grid frequency: 50Hz
Power factor: 1 (adjustable +/-0.8), Ingress protection: IP65
Operating Temperature Range: -25°C - 60°C, Protective Class: Class I

Date Received : 23 Sep., 2016
Date Test Conducted : 25 Sep., 2016 to 29 Oct., 2016
Test standards : EN 61000-6-1: 2007
EN 61000-6-3: 2007+A1: 2011
EN 61000-6-2:2005
EN 61000-6-4:2007+A1 : 2011

Test Result : Pass
Conclusion : The submitted samples complied with the above EMC standards.
Remark : TRF No.: EN 61000-6-1 , 6-3-a
Effective date: 25 March 2016

*****End of Page*****

Prepared and Checked By:

Guitar Huang
Project Engineer
Intertek Guangzhou

Approved By:

Strong Yao
Asst. Manager
Intertek Guangzhou

Signature

29 Nov., 2016 *Date*

This report is for the exclusive use of Intertek's Client and is provided pursuant to the agreement between Intertek and its Client. Intertek's responsibility and liability are limited to the terms and conditions of the agreement. Intertek assumes no liability to any party, other than to the Client in accordance with the agreement, for any loss, expense or damage occasioned by the use of this report. Only the Client is authorized to permit copying or distribution of this report and then only in its entirety. Any use of the Intertek name or one of its marks for the sale or advertisement of the tested material, product or service must first be approved in writing by Intertek. The observations and test results in this report are relevant only to the sample tested. This report by itself does not imply that the material, product, or service is or has ever been under an Intertek certification program. The test report only allows to be revised within three years from its original issued date unless further standard or the requirement was noticed.

Intertek Testing Services Shenzhen Ltd. Guangzhou Branch
Block E, No.7-2 Guang Dong Software Science Park, Caipin Road, Guangzhou Science City, GETDD Guangzhou, China
Tel / Fax: 86-20-8213 9688/86-20-3205 7538
© 2016 Intertek

CONTENT

TEST REPORT	1
CONTENT	2
1 TEST RESULTS SUMMARY	4
2 EMC RESULTS CONCLUSION.....	6
3 LABORATORY MEASUREMENTS.....	7
4 EMI TEST	8
4.1 EN 61000-6-3 CONTINUOUS CONDUCTED DISTURBANCE VOLTAGE TEST	8
4.1.1 <i>Used Test Equipment</i>	8
4.1.2 <i>Block Diagram of Test Setup</i>	8
4.1.3 <i>Test Setup and Procedure</i>	8
4.1.4 <i>Test Data</i>	9
4.1.5 <i>Emission Curve</i>	10
4.1.6 <i>Measurement Uncertainty</i>	11
4.2 EN 61000-6-3 , EN 61000-6-4 DISCONTINUOUS CONDUCTED DISTURBANCE VOLTAGE.....	11
4.3 EN 61000-6-3, EN 61000-6-4 EMISSION AT TELECOMMUNICATIONS/NETWORK PORTS.....	11
4.4 EN 61000-6-3 RADIATED EMISSION BELOW 1 GHz.....	12
4.4.1 <i>Used Test Equipment</i>	12
4.4.2 <i>Block Diagram of Test Setup</i>	12
4.4.3 <i>Test Setup and Procedure</i>	13
4.4.4 <i>Test Data</i>	13
4.4.5 <i>Emission Curve</i>	14
4.4.6 <i>Measurement uncertainty</i>	15
4.5 RADIATED EMISSION ABOVE 1 GHz	15
5 HARMONIC OF CURRENT	16
5.1 USED TEST EQUIPMENT	16
5.2 BLOCK DIAGRAM OF TEST SETUP.....	16
5.3 TEST SETUP AND PROCEDURE.....	16
5.4 TEST DATA	17
5.5 MEASUREMENT UNCERTAINTY.....	19
6 FLICKER.....	20
6.1 USED TEST EQUIPMENT	20
6.2 BLOCK DIAGRAM OF TEST SETUP.....	20
6.3 TEST SETUP AND PROCEDURE.....	20
6.3.1 <i>Definition</i>	20
6.3.2 <i>Test condition</i>	20
6.4 TEST DATA	21
6.5 MEASUREMENT UNCERTAINTY.....	21
7 EMS TEST	22
7.1 EN 61000-4-2(PURSUANT TO EN 61000-6-1/EN 61000-6-2) ELECTROSTATIC DISCHARGE IMMUNITY	22
7.1.1 <i>Used Test Equipment</i>	22
7.1.2 <i>Block Diagram of Test Setup</i>	23
7.1.3 <i>Test Setup and Procedure</i>	23
7.1.4 <i>Test Result</i>	25
7.2 EN 61000-4-6(PURSUANT TO EN 61000-6-1/EN 61000-6-2) INJECTED CURRENT (0.15 MHz TO 80 MHz)	27
7.2.1 <i>Used Test Equipment</i>	27

7.2.2	<i>Block Diagram of Test Setup</i>	27
7.2.3	<i>Test Result</i>	28
7.3	EN 61000-4-4(PURSUANT TO EN 61000-6-1/EN 61000-6-2) ELECTRICAL FAST TRANSIENT/BURST	29
7.3.1	<i>Used Test Equipment</i>	29
7.3.2	<i>Block Diagram of Test Setup</i>	29
7.3.3	<i>Test Setup and Procedure</i>	29
7.3.4	<i>Test Result</i>	30
7.4	EN 61000-4-5(PURSUANT TO EN 61000-6-1/EN 61000-6-2) SURGE IMMUNITY	31
7.4.1	<i>Used Test Equipment</i>	31
7.4.2	<i>Block Diagram of Test Setup</i>	31
7.4.3	<i>Test Setup and Procedure</i>	31
7.4.4	<i>Test Result</i>	32
7.5	EN 61000-4-11(PURSUANT TO EN 61000-6-1/ EN 61000-6-2) VOLTAGE DIPS AND INTERRUPTIONS.....	32
7.6	EN 61000-4-3(PURSUANT TO EN 61000-6-1/EN 61000-6-2) RADIATED ELECTROMAGNETIC FIELD IMMUNITY	33
7.6.1	<i>Used Test Equipment</i>	33
7.6.2	<i>Block Diagram of Test Setup</i>	34
7.6.3	<i>Test Setup and Procedure</i>	35
7.6.4	<i>Test Result</i>	36
7.7	EN 61000-4-8(PURSUANT TO EN 61000-6-1/ EN 61000-6-2) POWER FREQUENCY MAGNETIC FIELD IMMUNITY	38
7.7.1	<i>Used Test Equipment</i>	38
7.7.2	<i>Block Diagram of Test Setup</i>	38
7.7.3	<i>Test Setup and Procedure</i>	38
7.7.4	<i>Test Result</i>	39
8	APPENDIX I - PHOTOS OF TEST SETUP	40
9	APPENDIX II - PHOTOS OF EUT	44

1

TEST RESULTS SUMMARY

For EN 61000-6-3/EN 61000-6-1

Test Item	Standard	Result
Continuous conducted disturbance voltage	EN 61000-6-3: 2007+A1: 2011 Reference: EN 55022: 2010	Pass
Discontinuous conducted disturbance voltage	EN 61000-6-3: 2007+A1: 2011 Reference: EN 55014-1: 2006+A1: 2009	N/A
Emission at Telecommunications/ network Ports	EN 61000-6-3: 2007+A1: 2011 Reference: EN 55022: 2010	N/A
Radiated emission (30 MHz–1000 MHz)	EN 61000-6-3: 2007+A1: 2011 Reference: EN 55022: 2010	Pass
Radiated emission (1 GHz–6 GHz)	EN 61000-6-3: 2007+A1: 2011 Reference: EN 55022: 2010	N/A
Harmonic of current	EN 61000-6-3: 2007+A1: 2011 Reference: EN 61000-3-2: 2014	Pass
Flicker	EN 61000-6-3: 2007+A1: 2011 Reference: EN 61000-3-3: 2013	Pass
ESD immunity	EN 61000-6-1:2007 Reference: EN 61000-4-2: 2009	Pass
Radiated EM field immunity	EN 61000-6-1:2007 Reference: EN 61000-4-3 :2006 +A1:2008 + A2:2010	Pass
EFT immunity	EN 61000-6-1:2007 Reference: EN 61000-4-4: 2012	Pass
Surge immunity	EN 61000-6-1:2007 Reference: EN 61000-4-5: 2006	Pass
Inject current immunity	EN 61000-6-1:2007 Reference: EN 61000-4-6: 2009	Pass
Power frequency magnetic field immunity	EN 61000-6-1:2007 Reference: EN 61000-4-8: 2010	Pass
Voltage dips and interruption immunity	EN 61000-6-1:2007 Reference: EN 61000-4-11: 2004	N/A

For EN 61000-6-4/EN 61000-6-2:

Test Item	Standard	Result
Continuous conducted disturbance voltage	EN 61000-6-4:2007+A1:2011 Reference: EN 55022: 2010	Pass
Discontinuous conducted disturbance voltage	EN 61000-6-4:2007+A1:2011 Reference: EN 55022: 2010	Pass
<u>Common Mode Conducted Disturbance Voltage at Telecom. Ports</u>	EN 61000-6-4:2007+A1:2011 Reference: EN 55022: 2010	N/A
Common Mode Disturbance Current at Telecom. Ports	EN 61000-6-4:2007+A1:2011 Reference: EN 55022: 2010	N/A
Radiated emission	EN 61000-6-4:2007+A1:2011 Reference: EN 55022: 2010	Pass
ESD immunity	EN 61000-6-2: 2005 Reference: EN 61000-4-2: 2009	Pass
Inject current immunity	EN 61000-6-2: 2005 Reference: EN 61000-4-6: 2009	Pass
Surge immunity	EN 61000-6-2: 2005 Reference: EN 61000-4-5: 2006	Pass
EFT immunity	EN 61000-6-2: 2005 Reference: EN 61000-4-4: 2012	Pass
Radiated EM filed immunity	EN 61000-6-2: 2005 Reference: EN 61000-4-3 :2006 +A1:2008 + A2:2010	Pass
Voltage dips and interruption immunity	EN 61000-6-2: 2005 Reference: EN 61000-4-11: 2004	N/A
Power frequency magnetic field immunity	EN 61000-6-2: 2005 Reference: EN 61000-4-8: 2010	Pass

- Remark:**
1. The symbol “N/A” in above table means Not Applicable.
 2. When determining the test results, measurement uncertainty of tests has been considered.
 3. Since the Continuous conducted disturbance voltage and Radiated emission which in EN 61000-6-3 were more stricter than EN 61000-6-2, therefore only the EN 61000-6-3 test data Were shown in the report.

2

EMC Results Conclusion
(with Justification)

RE: EMC Testing Pursuant to EMC Directive 2014/30/EU Performed on the AC-coupled Storage Converter, Models: ME 3000SP.

We tested the AC-coupled Storage Converter, Models: ME 3000SP to determine if it was in compliance with the relevant EN standards as marked on the Test Results Summary. We found that the unit met the requirement of EN 61000-6-3, EN 61000-6-1 , EN 61000-6-4, EN 61000-6-2 standards when tested as received. The worst case test data was presented in this test report.

The production units are required to conform to the initial sample as received when the units are placed on the market.

3

LABORATORY MEASUREMENTS

Configuration Information

Equipment Under Test (EUT):	AC-coupled Storage Converter
Model:	ME 3000SP
Serial No.	Not Labeled
Support Equipment:	N/A
Rated Voltage:	Input voltage range: 42-58Vdc Nominal output voltage: 230 Vac
Condition of Environment:	Temperature : 22~28°C Relative Humidity: 35~60% Atmosphere Pressure 86~106kPa

Notes:

1. The EMI measurements had been made in the operating mode producing the largest emission in the frequency band being investigated consistent with normal applications.

An attempt had be made to maximize the emission by varying the configuration of the EUT.

2. The EMS measurements had been made in the frequency bands being investigated, with the EUT in the most susceptible operating mode consistent with normal applications. The configuration of the test sample had been varied to achieve maximum susceptibility.

3. Test Sites:

All tests were performed at:

CCIC Southern Electronic Product Testing(Shenzhen) Co.,Ltd.

Electronic Testing Building,Shahe Road,Xili,Nanshan District,Shenzhen.China

4 EMI TEST

4.1 EN 61000-6-3 Continuous Conducted Disturbance Voltage Test

Test Result: Pass

4.1.1 Used Test Equipment

Equipment No.	Equipment	Model	Manufacturer
A0304260	EMI Receiver	ESCS30	ROHDE&SCHWARZ
A0304221	LISN	ESH2-Z5	ROHDE&SCHWARZ
A9901141	Shielding	Site 3	Nanbo Tech

4.1.2 Block Diagram of Test Setup

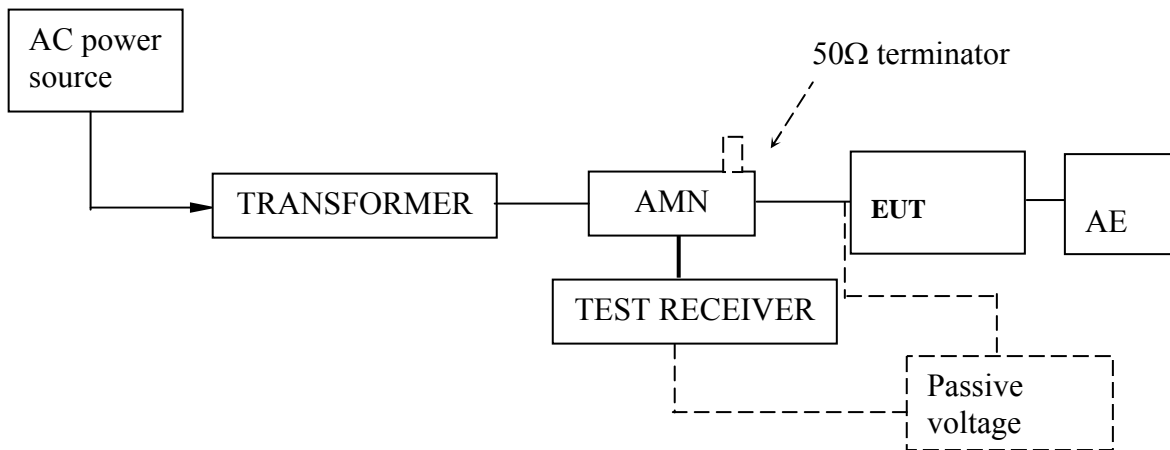

4.1.3 Test Setup and Procedure

The EUT was set to achieve the maximum emission level. The mains terminal disturbance voltage was measured with the EUT in a shielded room. The EUT was connected to AC power source through an Artificial Mains Network which provides a 50Ω linear impedance Artificial hand is used if appropriate (for handheld apparatus). The load/control terminal disturbance voltage was measured with passive voltage probe if appropriate.

The EUT was placed on a 0.8m high non-metallic table above a metallic plane, and 0.4m from wall of shielded room which is considered as Ground Reference Plane (GRP) (For floor standing EUT, was placed on a 0.1m high non-metallic supported on GRP) The EUT keeps a distance of at least 0.8m from any other of the metallic surface. The Artificial Mains Network is situated at a distance of 0.8m from the EUT.

During the test, mains lead of EUT excess 0.8m was folded back and forth parallel to the lead so as to form a horizontal bundle with a length between 0.3m and 0.4m.

The bandwidth of test receiver was set at 9 kHz. The frequency range from 150 kHz to 30MHz was checked.

4.1.4 Test Data

At main terminal: Pass

Tested Wire: Live

Operation Mode: Discharging mode(DC 58V/AC 230V)

Frequency [MHz]	Quasi-Peak		Average	
	Disturbance level [dB(μV)]	Permitted limit [dB(μV)]	Disturbance level [dB(μV)]	Permitted limit [dB(μV)]
	0.160	<55	65.5	<45
0.286	55.1	60.6	48.9	50.6
0.550	<46	56.0	<36	46.0
1.000	<46	56.0	<36	46.0
1.400	<46	56.0	<36	46.0
2.000	<46	56.0	<36	46.0
3.500	<46	56.0	<36	46.0
6.000	<50	60.0	<40	50.0
10.000	<50	60.0	<40	50.0
22.000	<50	60.0	<40	50.0
30.000	<50	60.0	<40	50.0

Tested Wire: Neutral

Operation Mode: Discharging mode(DC 58V/AC 230V)

Frequency [MHz]	Quasi-Peak		Average	
	Disturbance level [dB(μV)]	Permitted limit [dB(μV)]	Disturbance level [dB(μV)]	Permitted limit [dB(μV)]
	0.160	<55	65.5	<45
0.262	54.6	61.4	49.9	51.4
0.550	<46	56.0	<36	46.0
1.000	<46	56.0	<36	46.0
1.400	<46	56.0	<36	46.0
2.000	<46	56.0	<36	46.0
3.500	<46	56.0	<36	46.0
6.000	<50	60.0	<40	50.0
10.000	<50	60.0	<40	50.0
22.000	<50	60.0	<40	50.0
30.000	<50	60.0	<40	50.0

4.1.5 Emission Curve
At mains terminal:
Tested Wire: Live

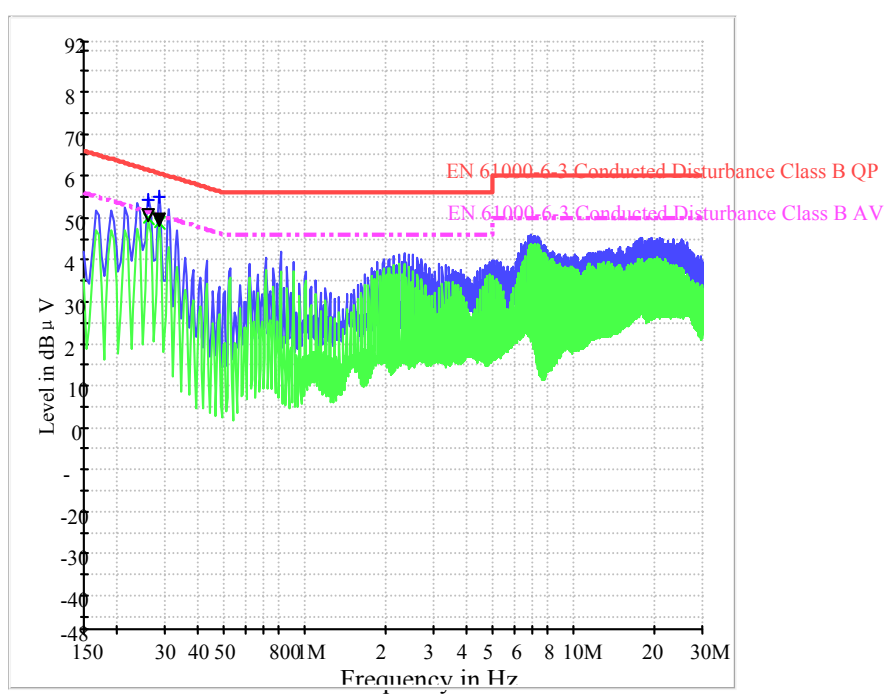

Tested Wire: Neutral

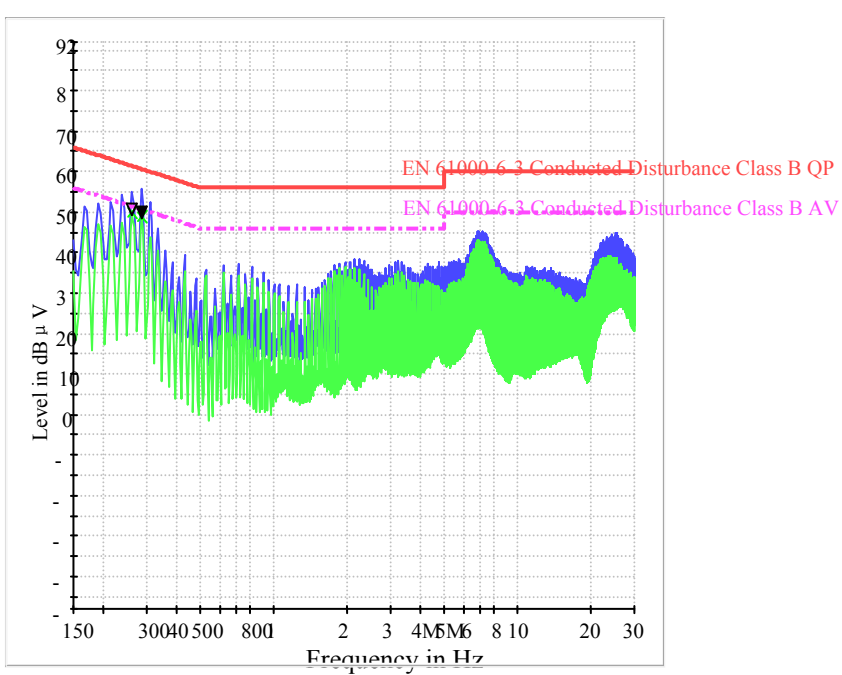

4.1.6 Measurement Uncertainty

The measurement uncertainty describes the overall uncertainty of the given measured value during the operation of the EUT.

Measurement uncertainty is calculated in accordance with CISPR 16-4-2: 2003.

Measurement uncertainty of mains terminal disturbance voltage in CISPR band B: 2.58 dB.

The measurement uncertainty is given with a confidence of 95%, $k=2$.

4.2 EN 61000-6-3, EN 61000-6-4 Discontinuous Conducted Disturbance Voltage

Test Result: Not Applicable

4.3 EN 61000-6-3, EN 61000-6-4 Emission at Telecommunications/network Ports

Test Result: Not Applicable

Remark: The test only apply to balanced telecommunication ports intended for connection to unshielded balanced pairs

4.4 EN 61000-6-3 Radiated Emission below 1 GHz

Test Result: Pass

4.4.1 Used Test Equipment

Equip. No.	Equipment	Model	Manufacturer
A0802520	10 m SAC	SAC-10MAC19.6*11.8*8.55 m	Albatross Projects GmbH
A0805559	EMI receiver	ESU8	R&S
A0805560	Bilog Antenna	VULB 09160	SCHWARZBECK

4.4.2 Block Diagram of Test Setup

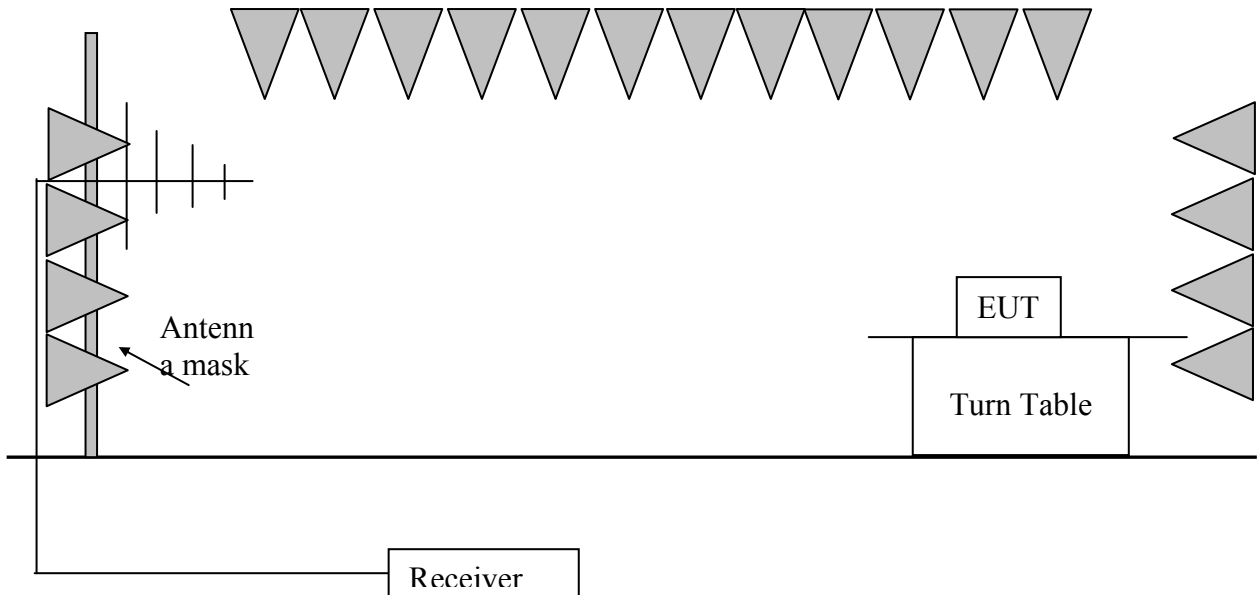

4.4.3 Test Setup and Procedure

The measurement was applied in a semi-anechoic chamber. The EUT and simulators were placed on a 0.8m high wooden turntable above the horizontal metal ground plane. The turn table rotated 360 degrees to determine the position of the maximum emission level. The EUT was set 10 meters away from the receiving antenna which was mounted on an antenna mask. The antenna moved up and down between from 1meter to 4 meters to find out the maximum emission level.

Broadband antenna was used as receiving antenna. Both horizontal and vertical polarization of the antenna was set on measurement. In order to find the maximum emission, all of the interface cables were manipulated according to EN55022 requirement during radiated test.

The bandwidth setting on R&S Test Receiver was 120 kHz.

The frequency range from 30MHz to 1000MHz was checked

4.4.4 Test Data

Polarization of the antenna: Horizontal

Operation Mode: Discharging mode(DC 58V/AC 230V)

Frequency (MHz)	QuasiPeak (dB μ V/m)	Meas. Time (ms)	Bandwidth (kHz)	Antenna height (cm)	Polarity	Turntable position (deg)	Corr. (dB)	Margin (dB)	Limit (dB μ V/m)
30.000000	17.4	1000.000	120.000	400.0	H	0.0	-16.2	12.6	30.0
33.160000	16.7	1000.000	120.000	400.0	H	0.0	-16.0	13.3	30.0
66.120000	14.6	1000.000	120.000	400.0	H	0.0	-15.9	15.4	30.0
69.520000	14.2	1000.000	120.000	400.0	H	0.0	-16.8	15.8	30.0
85.760000	13.9	1000.000	120.000	400.0	H	0.0	-18.7	16.1	30.0
110.520000	14.3	1000.000	120.000	400.0	H	0.0	-16.5	15.7	30.0

Polarization of the antenna: Vertical

Operation Mode: Discharging mode(DC 58V/AC 230V)

Frequency (MHz)	QuasiPeak (dB μ V/m)	Meas. Time (ms)	Bandwidth (kHz)	Antenna height (cm)	Polarity	Turntable position (deg)	Corr. (dB)	Margin (dB)	Limit (dB μ V/m)
30.000000	26.0	1000.000	120.000	100.0	V	0.0	-16.2	4.0	30.0
30.960000	24.8	1000.000	120.000	100.0	V	0.0	-16.1	5.2	30.0
59.360000	21.6	1000.000	120.000	100.0	V	0.0	-15.4	8.4	30.0
62.000000	21.4	1000.000	120.000	100.0	V	0.0	-15.4	8.6	30.0
72.840000	24.8	1000.000	120.000	100.0	V	0.0	-17.5	5.2	30.0
79.000000	22.8	1000.000	120.000	100.0	V	0.0	-18.8	7.2	30.0

4.4.5 Emission Curve

Polarization of the antenna: Horizontal

Operation Mode: Discharging mode(DC 58V/AC 230V)

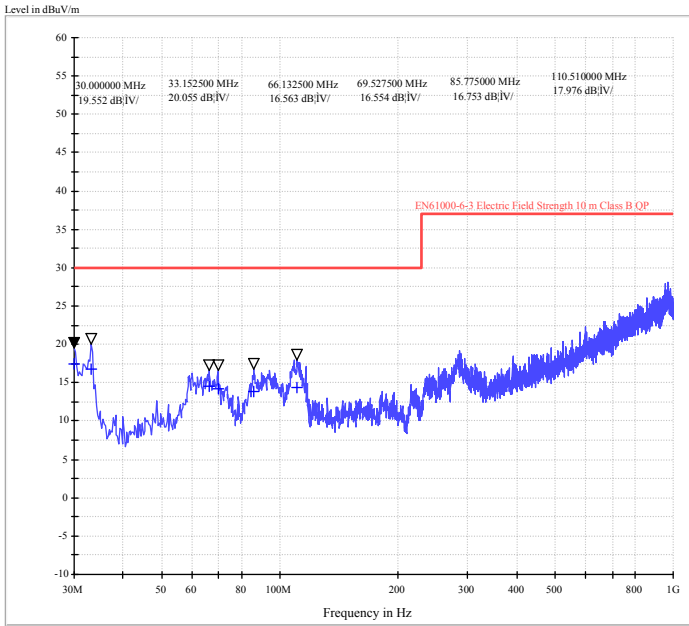

Polarization of the antenna: Vertical

Operation Mode: Discharging mode(DC 58V/AC 230V)

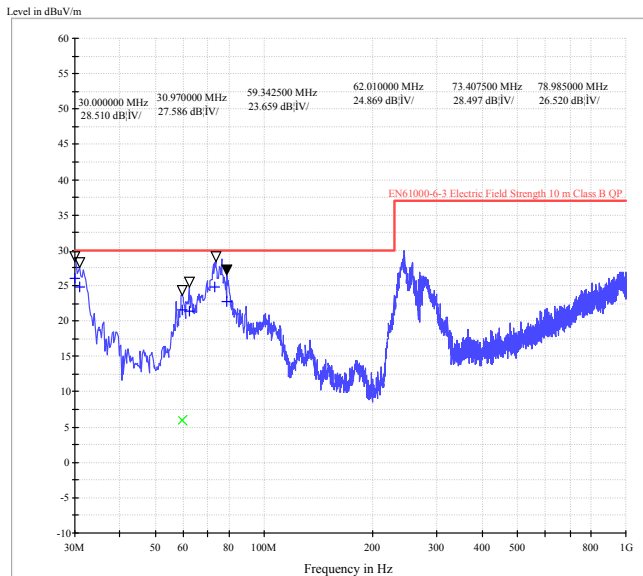

4.4.6 Measurement uncertainty

The measurement uncertainty describes the overall uncertainty of the given measured value during the operation of the EUT.

Measurement uncertainty is calculated in accordance with CISPR 16-4-2:2003.

Measurement uncertainty of radiated emission: 4.87 dB.

The measurement uncertainty is given with a confidence of 95%, $k=2$.

4.5 Radiated Emission above 1 GHz

Test Result: Not Applicable

Remark: The highest internal source of the EUT is not more than 108 MHz, so the measurement above 1000 MHz is not applicable.

5 Harmonic of Current

Test Result: Pass

5.1 Used Test Equipment

Equipment No.	Equipment	Model	Manufacturer
A150202183	3 phases harmonic analyzer	DPA503N	EM TEST
A150202184	3 Phases Flicker Impedance	AIF 503N75	EM TEST

5.2 Block Diagram of Test Setup

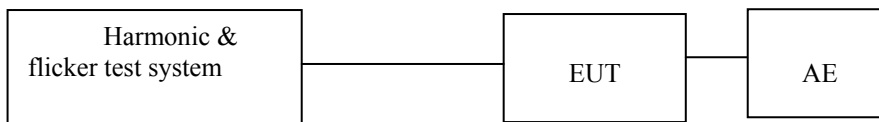

5.3 Test Setup and Procedure

Harmonics of the fundamental current were measured up to 40 order harmonics using a digital power meter with an analogue output and frequency analyser which was integrated in the harmonic & flicker test system. The measurements were carried out under steady conditions.

5.4 Test Data

Average harmonic current results				
Hn	I _{eff} [A]	% of Limit	Limit [A]	Result
1	9.610			
2	11.459E-3			PASS
3	94.242E-3	4.553	2.07	PASS
4	8.456E-3			PASS
5	27.183E-3			PASS
6	6.222E-3			PASS
7	20.310E-3			PASS
8	6.275E-3			PASS
9	25.622E-3			PASS
10	6.383E-3			PASS
11	32.094E-3			PASS
12	7.979E-3			PASS
13	33.531E-3			PASS
14	6.259E-3			PASS
15	32.671E-3			PASS
16	4.926E-3			PASS
17	35.831E-3			PASS
18	4.629E-3			PASS
19	30.700E-3			PASS
20	4.958E-3			PASS
21	27.875E-3			PASS
22	4.951E-3			PASS
23	25.038E-3			PASS
24	4.323E-3			PASS
25	21.910E-3			PASS
26	4.452E-3			PASS
27	19.418E-3			PASS
28	6.443E-3			PASS
29	17.082E-3			PASS
30	6.327E-3			PASS
31	15.330E-3			PASS
32	5.036E-3			PASS
33	13.438E-3			PASS
34	3.663E-3			PASS
35	11.690E-3			PASS
36	3.340E-3			PASS
37	10.232E-3			PASS
38	3.357E-3			PASS
39	9.458E-3			PASS
40	3.088E-3			PASS

Maximum harmonic current results

Hn	I _{eff} [A]	% of Limit	Limit [A]	Result
1	9.612	2.080	4.60	PASS
2	13.369E-3			
3	95.675E-3			
4	10.940E-3			
5	28.506E-3			
6	8.508E-3			
7	21.496E-3			
8	7.393E-3			
9	27.152E-3			
10	7.807E-3			
11	33.384E-3			
12	9.351E-3			
13	34.736E-3			
14	7.312E-3			
15	33.767E-3			
16	5.633E-3			
17	36.753E-3			
18	5.548E-3			
19	31.756E-3			
20	5.779E-3			
21	28.664E-3			
22	5.797E-3			
23	25.748E-3			
24	5.012E-3			
25	22.822E-3			
26	5.106E-3			
27	20.134E-3			
28	7.539E-3			
29	17.875E-3			
30	7.327E-3			
31	16.576E-3			
32	5.970E-3			
33	14.236E-3			
34	4.305E-3			
35	12.641E-3			
36	3.796E-3			
37	10.857E-3			
38	3.890E-3			
39	10.445E-3			
40	3.486E-3			

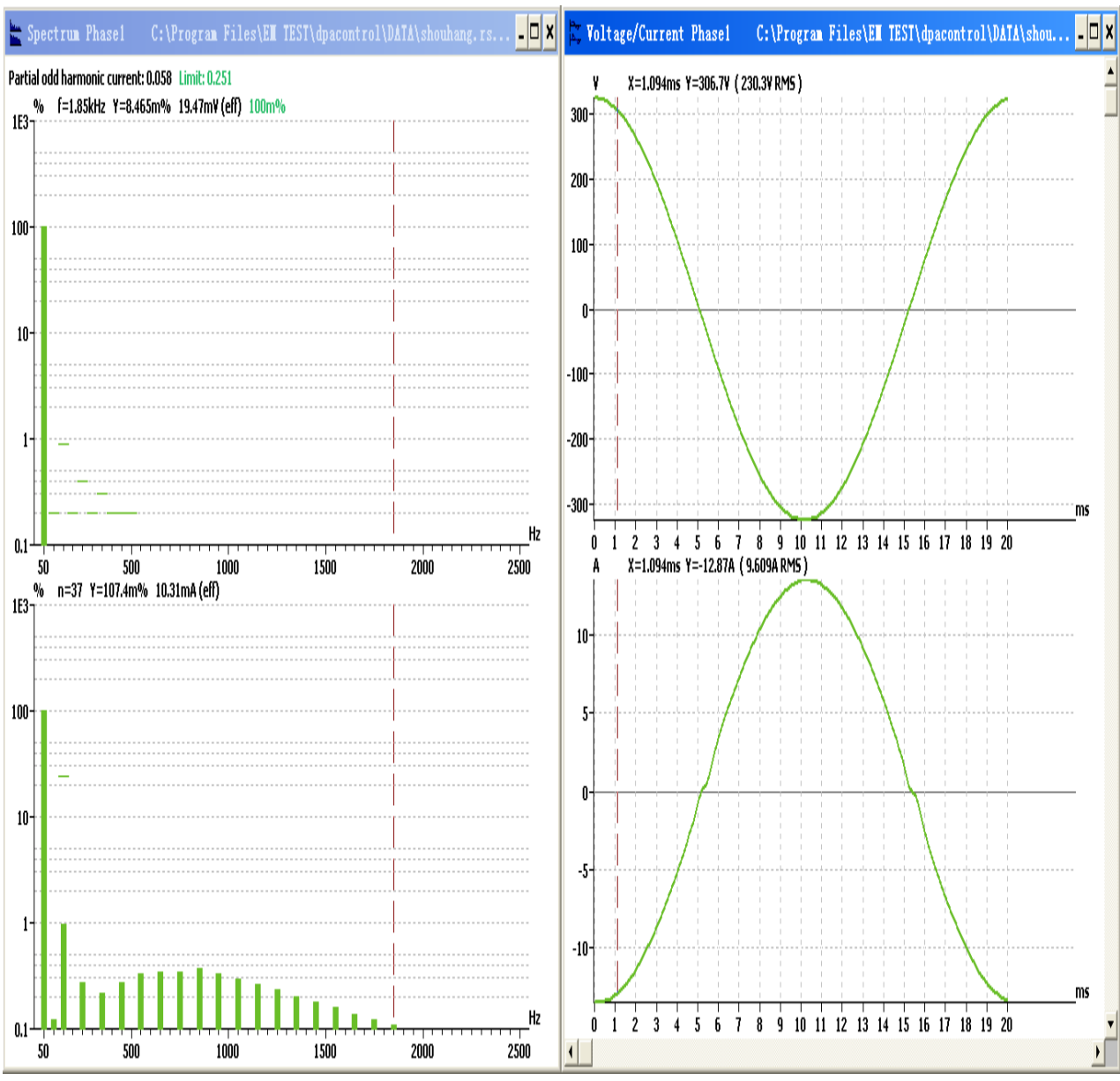

5.5 Measurement Uncertainty

The measurement uncertainty for harmonic test is under consideration according to CISPR 16-4-2:2003.

6 Flicker

Test Result: Pass

6.1 Used Test Equipment

Equipment No.	Equipment	Model	Manufacturer
A150202183	3 phases harmonic analyzer	DPA503N	EM TEST
A150202184	3 Phases Flicker Impedance	AIF 503N75	EM TEST

6.2 Block Diagram of Test Setup



6.3 Test Setup and Procedure

6.3.1 Definition

- Flicker: impression of unsteadiness of visual sensation induced by a lighting stimulus whose luminance or spectral distribution fluctuates with time.
- Pst: Short-term flicker indicator The flicker severity evaluated over a short period (in minutes); Pst=1 is the conventional threshold of irritability
- Plt: long-term flicker indicator; the flicker severity evaluated over a long period (a few hours). Using successive Pst value.
- dc: the relative steady-state voltage change
- dmax: the maximum relative voltage change
- d(t): the value during a voltage change

6.3.2 Test condition

The EUT was set to produce the most unfavourable sequence of voltage changes.

6.4 Test Data

Maximum Flicker results

	EUT values	Limit	Result
Pst	0.041	1.00	PASS
Plt	0.029	0.65	PASS
dc [%]	0.039	3.30	PASS
dmax [%]	0.176	4.00	PASS
dt [s]	0.000	0.50	PASS

6.5 Measurement Uncertainty

Measurement uncertainty for voltage fluctuation and flicker is under consideration according to CISPR 16-4-2:2003.

7 EMS TEST

Performance Criteria:

- Criterion A: The apparatus shall continue to operate as intended during the test. No degradation of performance or loss of function is allowed below a performance level (or permission loss of performance) specified by the manufacturer, when the apparatus is used as intended. If the minimum performance level or the permissible performance loss is not specified by the manufacturer, then either of these may be derived from the product description and documentation and from what the user may reasonably expect from the apparatus if used as intended.
- Criterion B: The apparatus shall continue to operate as intended after the test. No degradation of performance or loss of function is allowed below a performance level (or permission loss of performance) specified by the manufacturer, when the apparatus is used as intended. During the test, degradation of performance is allowed, however, no change of actual operating state or stored data is allowed. If the minimum performance level or the permissible performance loss is not specified by the manufacturer, then either of these may be derived from the product description, and documentation, and from what the user may reasonably expect from the apparatus if used as intended.
- Criterion C: Temporary loss of function is allowed, provided the function is self-recoverable or can be restored by the operation of the controls, or by any operation specified in the instruction for use.

Measurement Uncertainty

According to CISPR 16-4-2:2003, measurement uncertainty to immunity test is under consideration.

7.1 EN 61000-4-2(Pursuant to EN 61000-6-1/EN 61000-6-2) Electrostatic Discharge Immunity

Tested Port: Enclosure

Performance criterion: B

Test Result: Pass

7.1.1 Used Test Equipment

Equipment No.	Equipment	Model	Manufacturer
A0103108	ESD Test System	FESD16000	HAREFELY

7.1.2 Block Diagram of Test Setup

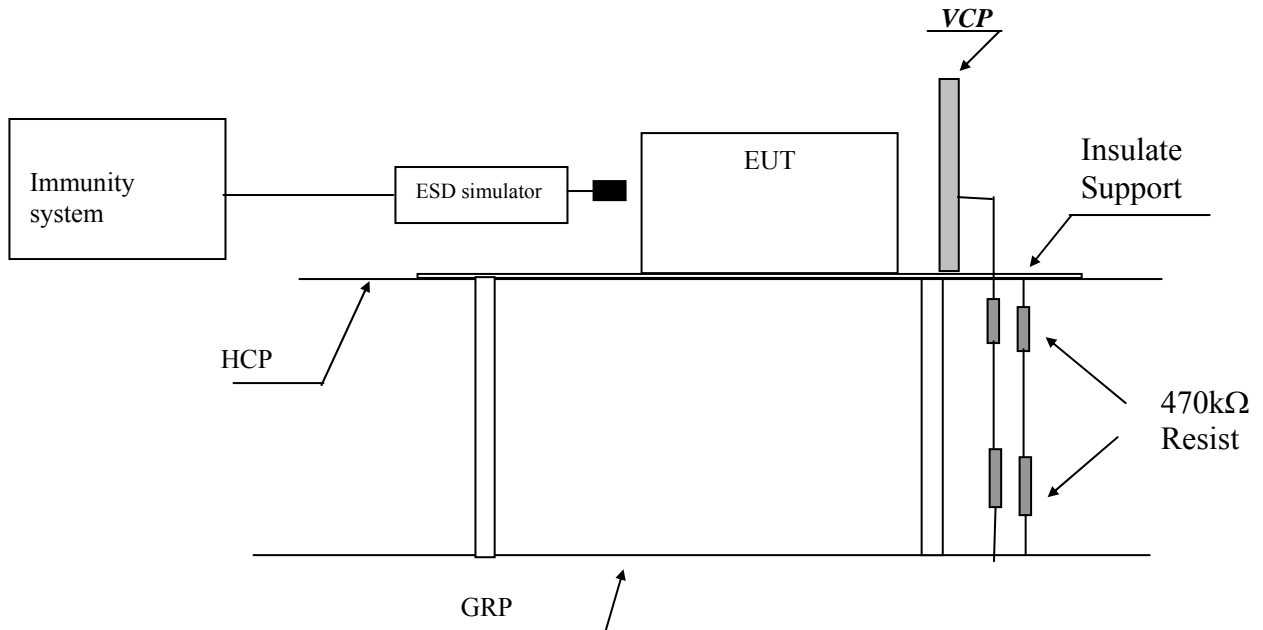

Note: HCP means Horizontal Coupling Plane,
 VCP means Vertical Coupling Plane
 GRP means Ground Reference Plane

7.1.3 Test Setup and Procedure

The EUT was put on a 0.8m high wooden tabel/0.1m high for floor standing equipment standing on the ground reference plane(GRP) 3m by 2m in size, made by iron 1.0 mm thick.

A horizontal coupling plane(HCP) 1.6m by 0.8m in size was placed on the table, and the EUT with its cables were isolated from the HCP by an insulating support thick than 0.5mm. The VCP 0.5m by 0.5m in size & HCP were constructed from the same material type & thinkmess as that of the GRP, and connected to the GRP via a 470kΩ resistor at each end.

The distance between EUT and any of the other metallic surface excepted the GRP, HCP & VCP was greater than 1m.

The EUT was arranged and connected according to its functional requirements.
 The EUT was arranged and connected according to its functional requirements

Direct static electricity discharges was applied only to those points and surface which are accessible to personnel during normal usage.

Test voltage was increased from the minimum to the selected test level and with single discharge.

On each preselected points 10 times of each polarity single discharge were applied The time interval between successive single discharges is 1s.

The ESD generator was held perpendicular to the surface to which the discharge is applied. The discharge return cable of the generator was kept at a distance of 0.2m whilst the discharge is being applied. During the contact discharges, the tip of the discharge electrode was touch the EUT before the discharge switch is operated. During the air discharges, the round discharge tip of the discharge electrode was approached as fast as possible to touch the EUT.

Indirect discharge was conducted to objects placed near the EUT, simulated by applying the discharges of the ESD generator to a coupling plane, in the contact discharge mode.

After each discharge, the ESD generator was removed from the EUT, the generator is then retriggered for a new single discharge. For ungrounded product, a grounded carbon fibre brush with bleeder resistors ($2 \times 470 \text{ k}\Omega$) in the grounding cable was used after each discharge to remove remnant electrostatic voltage.

10 times of each polarity single discharge were applied to HCP and VCP. The detail selected points are listed in the following table.

7.1.4 Test Result

For EN 61000-6-1

Direct Application of ESD

Direct Contact Discharge

Applied Voltage (kV)	No. of Discharge for each point	Result	Discharged Points
2, 4	20	Pass	Accessible metal parts of the EUT Conductive substrate with coating which is not declared to be insulating

Direct Air Discharge

Applied Voltage (kV)	No. of Discharge for each point	Result	Discharged Points
2, 4, 8	20	Pass	All accessible points where contact discharge cannot be applied such as Displays, Indicators light, Keyboard, Button, Switch, Knob, Air gap, Slots, Hole and so on

Indirect Application of ESD

Horizontal Coupling Plane under the EUT

Applied Voltage (kV)	No. of Discharge for each point	Result	Discharged Point
2, 4	20	Pass	At the front edge of each HCP opposite the centre point of each unit of the EUT

Vertical Coupling Plane beside the EUT

Applied Voltage (kV)	No. of Discharge for each point	Result	Discharged Point
2, 4	20	Pass	The centre of the vertical edge of the coupling plane

For EN 61000-6-2:

Direct Application of ESD

Direct Contact Discharge

Applied Voltage (kV)	No. of Discharge for each point	Result	Discharged Points
2, 4	20	Pass	Accessible metal parts of the EUT Conductive substrate with coating which is not declared to be insulating

Direct Air Discharge

Applied Voltage (kV)	No. of Discharge for each point	Result	Discharged Points
2, 4, 8	20	Pass	All accessible points where contact discharge cannot be applied such as Displays, Indicators light, Keyboard, Button, Switch, Knob, Air gap, Slots, Hole and so on

Indirect Application of ESD

Horizontal Coupling Plane under the EUT

Applied Voltage (kV)	No. of Discharge for each point	Result	Discharged Point
2, 4	20	Pass	At the front edge of each HCP opposite the centre point of each unit of the EUT

Vertical Coupling Plane beside the EUT

Applied Voltage (kV)	No. of Discharge for each point	Result	Discharged Point
2, 4	20	Pass	The centre of the vertical edge of the coupling plane

7.2 EN 61000-4-6(Pursuant to EN 61000-6-1/EN 61000-6-2) Injected Current (0.15 MHz to 80 MHz)

Tested Port: AC power DC power Functional earth Signal/Control
Performance criterion: A
Test Result: Pass

7.2.1 Used Test Equipment

Equipment No.	Equipment	Model	Manufacturer
A0304261	Singnal Gernarator	SML02	ROHDE&SCHWARZ
A0304255	Power Amplifier	75A250AM(0.01-250MHz)	Amplifier Research
--	CDN	M2	ROHDE&SCHWARZ
--	CDN	M3	ROHDE&SCHWARZ
A0304258	Electromagnetic Coupling Clamp	F2031	ROHDE&SCHWARZ
A0304257	High Current Injection Clamp	BCI Clamp	ROHDE&SCHWARZ
A0304210	Shielding Room	Site 4	Nanbo Tech

7.2.2 Block Diagram of Test Setup

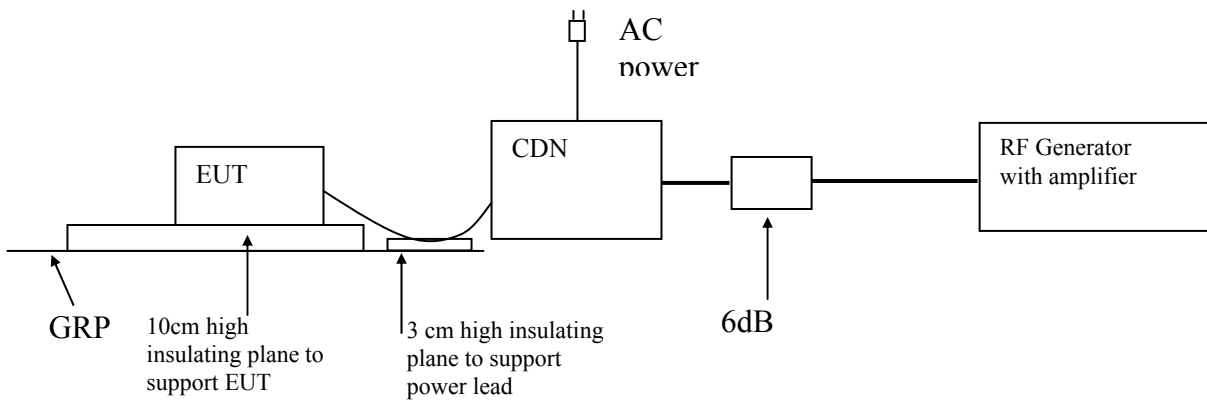

7.2.3 Test Result

For EN 61000-6-1:

Port:	Frequency (MHz)	Level (Pursuant to EN 61000-6-1)	Result
A.C. Power Lines	0.15 to 80	3V (r.m.s.)	Pass
D.C. Power Lines	0.15 to 80	3V (r.m.s.)	Pass
Signal Lines	0.15 to 80	3V (r.m.s.)	N/A
Control Lines	0.15 to 80	3V (r.m.s.)	N/A
Functional Earth	0.15 to 80	3V (r.m.s.)	N/A

For EN 61000-6-2

Port:	Frequency (MHz)	Level (Pursuant to EN 61000-6-2)	Result
A.C. Power Lines	0.15 to 80	10V (r.m.s.)	Pass
D.C. Power Lines	0.15 to 80	10V (r.m.s.)	Pass
Signal Lines	0.15 to 80	10V (r.m.s.)	N/A
Control Lines	0.15 to 80	10V (r.m.s.)	N/A
Functional Earth	0.15 to 80	10V (r.m.s.)	N/A

7.3 EN 61000-4-4(Pursuant to EN 61000-6-1/EN 61000-6-2) Electrical Fast Transient/Burst
Tested Port: AC power DC power Functional earth Signal/Control
Performance criterion: B
Test Result: Pass

7.3.1 Used Test Equipment

Equipment No.	Equipment	Model	Manufacturer
A0712511	EFT/Surge Test System	TSS 500 M10	EMTEST

7.3.2 Block Diagram of Test Setup

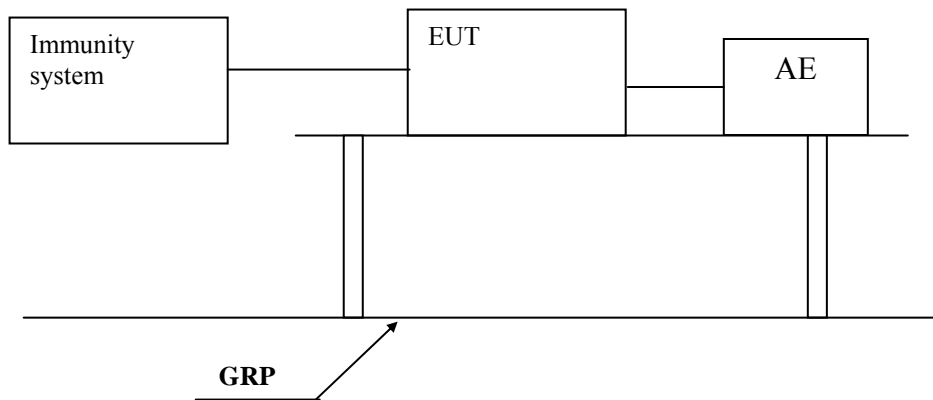

7.3.3 Test Setup and Procedure

The EUT was placed on a 0.1m high wooden table, standing on the ground reference plane 3m by 2m in size, made by steel 1mm thick.

The distance between the EUT and any other of the metallic surface except the GRP is greater than 0.5m.

The mains lead excess than 0.5m is folded to avoid a flat coil and situated at a distance of 0.1m above the ground reference plane to insure the distance between the coupling device and the EUT were 0.5m.

The EUT was arranged and connected to satisfy its functional requirement and supplied by the coupling-decoupling network.

7.3.4 Test Result

For EN 61000-6-1:

Level (Pursuant to EN 61000-6-1)	Polarity	A.C. Power supply line and functional earth terminal	D.C. Power Lines, Signal Line & Control Line
0.5kV	+	N/A	Pass
0.5kV	-	N/A	Pass
1kV	+	Pass	N/A
1kV	-	Pass	N/A

For EN 61000-6-2:

Level (Pursuant to EN 61000-6-2)	Polarity	A.C. Power supply line and functional earth terminal	D.C. Power Lines, Signal Line & Control Line
1kV	+	N/A	Pass
1kV	-	N/A	Pass
2kV	+	Pass	N/A
2kV	-	Pass	N/A

7.4 EN 61000-4-5(Pursuant to EN 61000-6-1/EN 61000-6-2) Surge Immunity

Tested Port: AC power DC power

Performance criterion: B

Test Result: Pass

7.4.1 Used Test Equipment

Equipment No.	Equipment	Model	Manufacturer
A0712511	EFT/Surge Test System	TSS 500 M10	EMTEST

7.4.2 Block Diagram of Test Setup

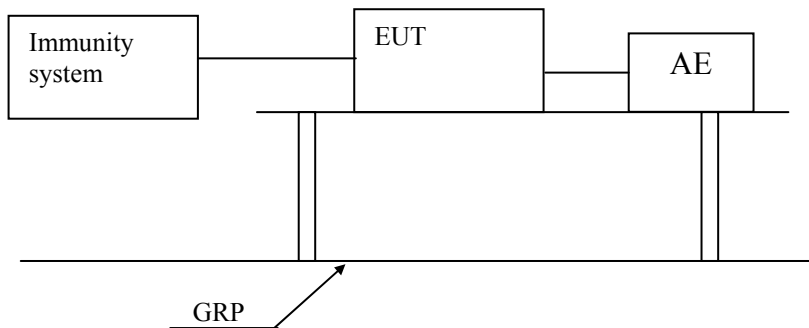

7.4.3 Test Setup and Procedure

The surge is to be applied to the EUT power supply terminals via the capacitive coupling network.

Decoupling networks are required in order to avoid possible adverse effects on equipment not under test that may be powered by the same lines and to provide sufficient decoupling impedance to the surge wave so that the specified wave may be developed on the lines under test.

The EUT was arranged and connected according to its functional requirements. The EUT was placed on a 0.1m high wooden support above the GRP, supplied by the coupling-decoupling network, and arranged and connected to satisfy its functional requirement and the power cord between the EUT and the coupling/decoupling network was less than 2 meters.

Surge is applied to the EUT power supply terminals.

7.4.4 Test Result

For EN 61000-6-1:

Tested Port	Level (Pursuant to EN 61000-6-1)	Result
AC power	Line to line ± 0.5 kV, ± 1 kV	Pass
AC power	Line to earth ± 0.5 kV, ± 1 kV, ± 2 kV	Pass
DC power	Line to line ± 0.5 kV	Pass
DC power	Line to earth ± 0.5 kV	Pass

For EN 61000-6-2:

Tested Port	Level (Pursuant to EN 61000-6-2)	Result
AC power	Line to line ± 0.5 kV, ± 1 kV	Pass
AC power	Line to earth ± 0.5 kV, ± 1 kV, ± 2 kV	Pass
DC power	Line to line ± 0.5 kV	Pass
DC power	Line to earth ± 0.5 kV	Pass

7.5 EN 61000-4-11(Pursuant to EN 61000-6-1/ EN 61000-6-2) Voltage Dips and Interruptions

Test Result: Not Applicable

Remark: the test only applicable to the AC input port.

7.6 EN 61000-4-3(Pursuant to EN 61000-6-1/EN 61000-6-2) Radiated Electromagnetic Field Immunity

Tested Port: Enclosure
Performance criterion: A
Test Result: Pass

7.6.1 Used Test Equipment

Equipment No.	Equipment	Model	Manufacturer
A0304261	Signal Generator	SML02	R&S
A0304247	Power Amplifier	150W1000(80-1000MHz)	Amplifier Research
A0304248	Power Amplifier	25S1g4AM1(800MHz-4.2GHz)	Amplifier Research
A0304249	Broadband Antenna	AT1080(80MHz-1000MHz)	Amplifier Research
A0304250	Horn Antenna	AT4002A(800MHz-4.2MHz)	Amplifier Research
A0304210	Anechoic Chamber	H-249	Albatross

7.6.2 Block Diagram of Test Setup

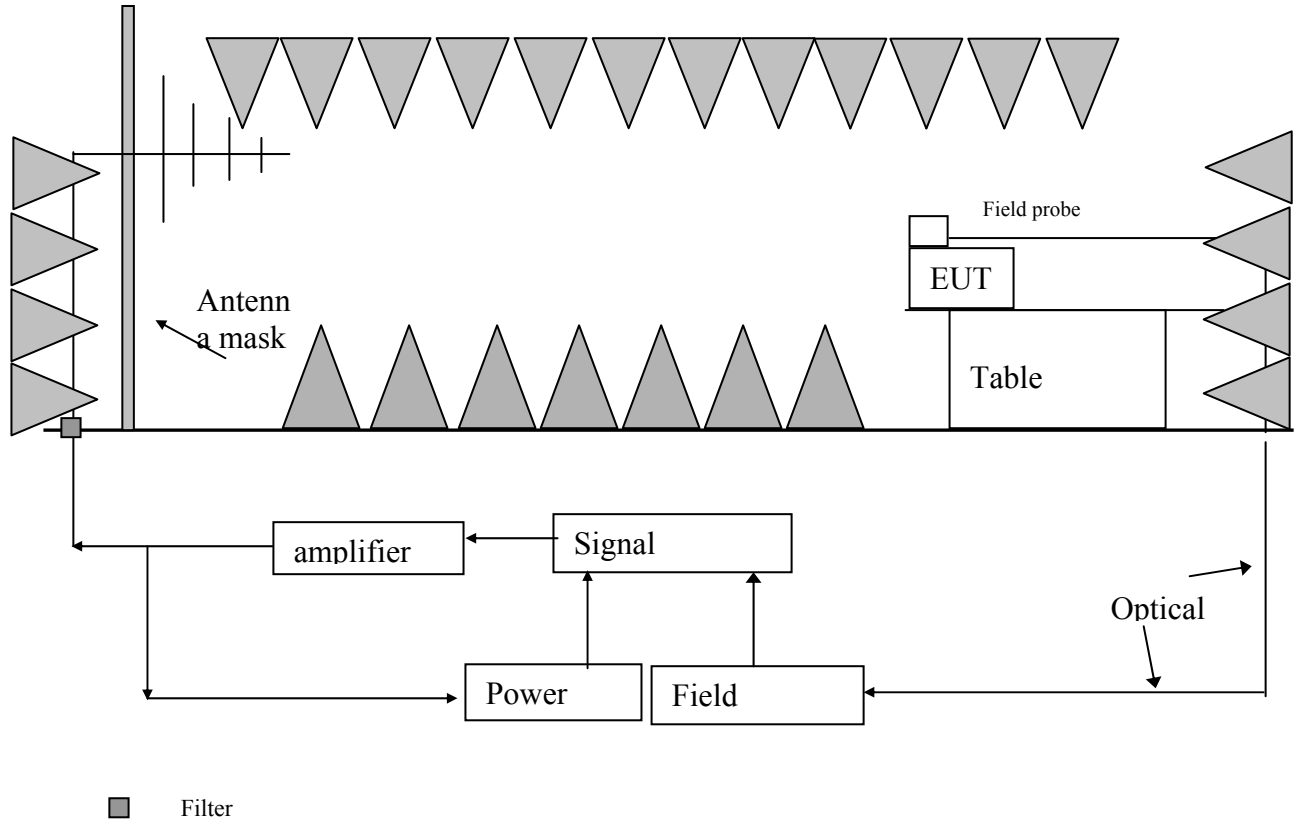

7.6.3 Test Setup and Procedure

The test was conducted in an fully anechoic chamber to maintain a uniform field of sufficient dimensions with respect to the EUT, and also in order to comply with various national and international laws prohibiting interference to radio communications.

The equipment is placed in the test facility on a non-conducting table 0.8m high (for floor standing EUT, is placed on a non-conducting support 0.1m height).

The EUT was placed on the uniform calibrated plane which is 3V/m and 1V/mEM field.

For all ports connected to EUT, manufacturer specified cable type and length was used, for those cables no specification, unshielded cable applied.

Wire is left exposed to the electromagnetic field for a distance of 1m from the EUT.

The EUT was arranged and connected according to its functional requirements

Before testing, the intensity of the established field strength have been checked by placing the field sensor at a calibration grid point, and with the field generating antenna and cables in the same positions as used for the calibration, the forward power needed to give the calibrated field strength was measured.

Spot checks was made at a number of calibration grid points over the frequency range 80 to 1000MHz and 1.4 to 2.7 GHz, both polarizations was checked.

After calibration, the EUT is initially placed with one face coincident with the calibration plane.

The frequency range is swept from 80 to 1000MHz and 1.4 to 2.7 GH, with the signal 80% amplitude modulated with a 1 kHz sinewave, pausing to adjust the r.f. signal level.

The dwell time at each frequency was 3s so as that the EUT to be exercised and be able to respond.

The step size was 1% of the fundamental with linear interpolation between calibrated points. Test was performed with the generating antenna facing each of the four sides of the EUT.

7.6.4 Test Result

For EN 61000-6-1:

Frequency (MHz)	Exposed Side	Field Strength (V/m)	Result
80 to 1000	Front	3V/m (r.m.s.)	Pass
80 to 1000	Left	3V/m (r.m.s.)	Pass
80 to 1000	Rear	3V/m (r.m.s.)	Pass
80 to 1000	Right	3V/m (r.m.s.)	Pass

Frequency (GHz)	Exposed Side	Field Strength (V/m)	Result
1.4 to 2.0	Front	3V/m (r.m.s.)	Pass
1.4 to 2.0	Left	3V/m (r.m.s.)	Pass
1.4 to 2.0	Rear	3V/m (r.m.s.)	Pass
1.4 to 2.0	Right	3V/m (r.m.s.)	Pass

Frequency (GHz)	Exposed Side	Field Strength (V/m)	Result
2.0 to 2.7	Front	1V/m (r.m.s.)	Pass
2.0 to 2.7	Left	1V/m (r.m.s.)	Pass
2.0 to 2.7	Rear	1V/m (r.m.s.)	Pass
2.0 to 2.7	Right	1V/m (r.m.s.)	Pass

For EN 61000-6-2:

Frequency (MHz)	Exposed Side	Field Strength (V/m)	Result
80 to 1000	Front	10V/m (r.m.s.)	Pass
80 to 1000	Left	10V/m (r.m.s.)	Pass
80 to 1000	Rear	10V/m (r.m.s.)	Pass
80 to 1000	Right	10V/m (r.m.s.)	Pass

Frequency (GHz)	Exposed Side	Field Strength (V/m)	Result
1.4 to 2.0	Front	3V/m (r.m.s.)	Pass
1.4 to 2.0	Left	3V/m (r.m.s.)	Pass
1.4 to 2.0	Rear	3V/m (r.m.s.)	Pass
1.4 to 2.0	Right	3V/m (r.m.s.)	Pass

Frequency (GHz)	Exposed Side	Field Strength (V/m)	Result
2.0 to 2.7	Front	1V/m (r.m.s.)	Pass
2.0 to 2.7	Left	1V/m (r.m.s.)	Pass
2.0 to 2.7	Rear	1V/m (r.m.s.)	Pass
2.0 to 2.7	Right	1V/m (r.m.s.)	Pass

7.7 EN 61000-4-8(Pursuant to EN 61000-6-1/ EN 61000-6-2) Power Frequency Magnetic Field Immunity

Tested Port: Enclosure
Performance criterion: A

7.7.1 Used Test Equipment

Equipment No.	Equipment	Model	Manufacturer
A0103109	Magnetic Field Tester	MAG 100.1	HAEFELY

7.7.2 Block Diagram of Test Setup

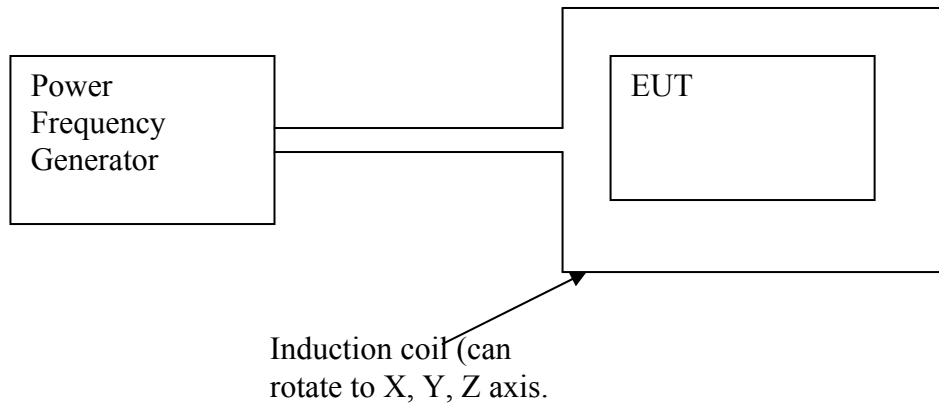

7.7.3 Test Setup and Procedure

Put EUT into center of induction coil(with suitable dimensions) in the testing.

For tabletop equipment:

The EUT was placed on a big enough wooden desk with height of 0.8m and operating as intended. The equipment shall be subjected to the test magnetic field by using the induction coil of standards(1m*1m).

The induction coil shall be rotated by 90⁰ in order to expose the EUT to the test field with different orientations.

For Floor-standing equipment:

The EUT was placed on big enough wooden desk with height of 0.1m and operating as intended. The equipment shall be subjected to the test magnetic field by using induction coils of suitable dimensions ; the test shall be repeated by moving and shifting the induction coils, in order to test the whole volume of the EUT for each orthogonal direction. The test shall be repeated with the coil shifted to different position along the side of the EUT, in steps corresponding to 50% of the shortest side of the coil.

The induction coil shall then be rotated by 90⁰ in order to expose the EUT to the test field with different orientations and the same procedure followed.

7.7.4 Test Result

For EN 61000-6-1:

Mains frequency: **50Hz** **60Hz**

Orientations of induction coil	Magnetic Field Strength (A/m)	Result
X	3A/m	Pass
Y	3A/m	Pass
Z	3A/m	Pass

For EN 61000-6-2:

Mains frequency: **50Hz** **60Hz**

Orientations of induction coil	Magnetic Field Strength (A/m)	Result
X	30A/m	Pass
Y	30A/m	Pass
Z	30A/m	Pass

8 Appendix I - Photos of test setup

Conducted Emission

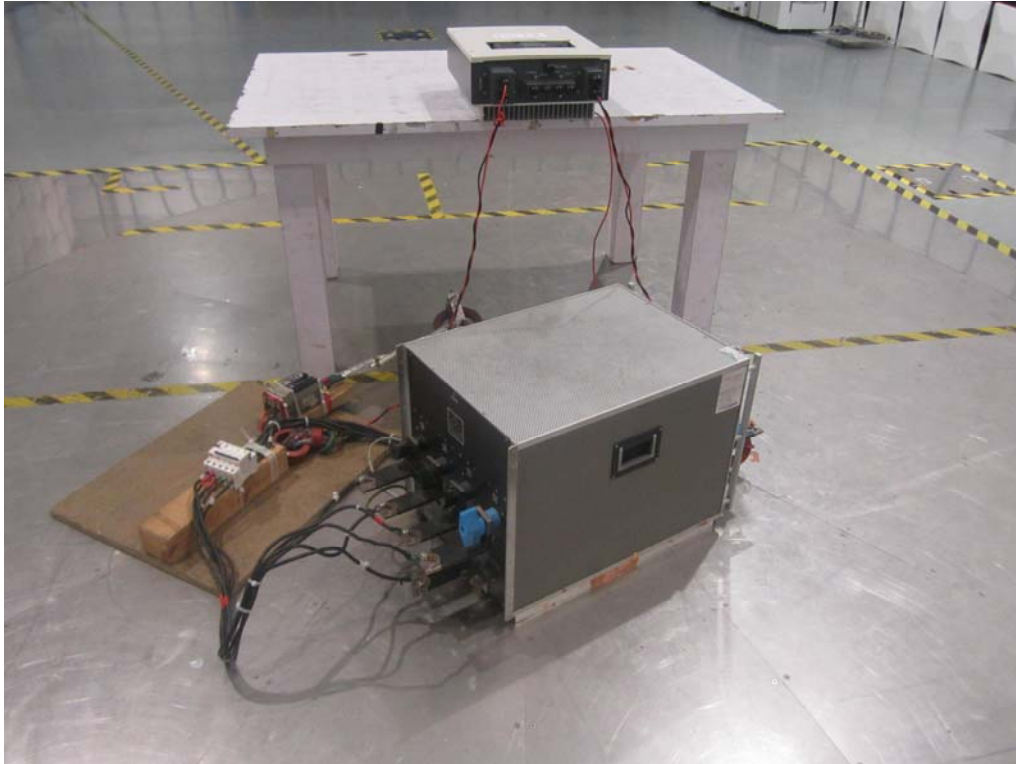

Radiated Emission



Harmonic of current and Flicker



ESD Immunity

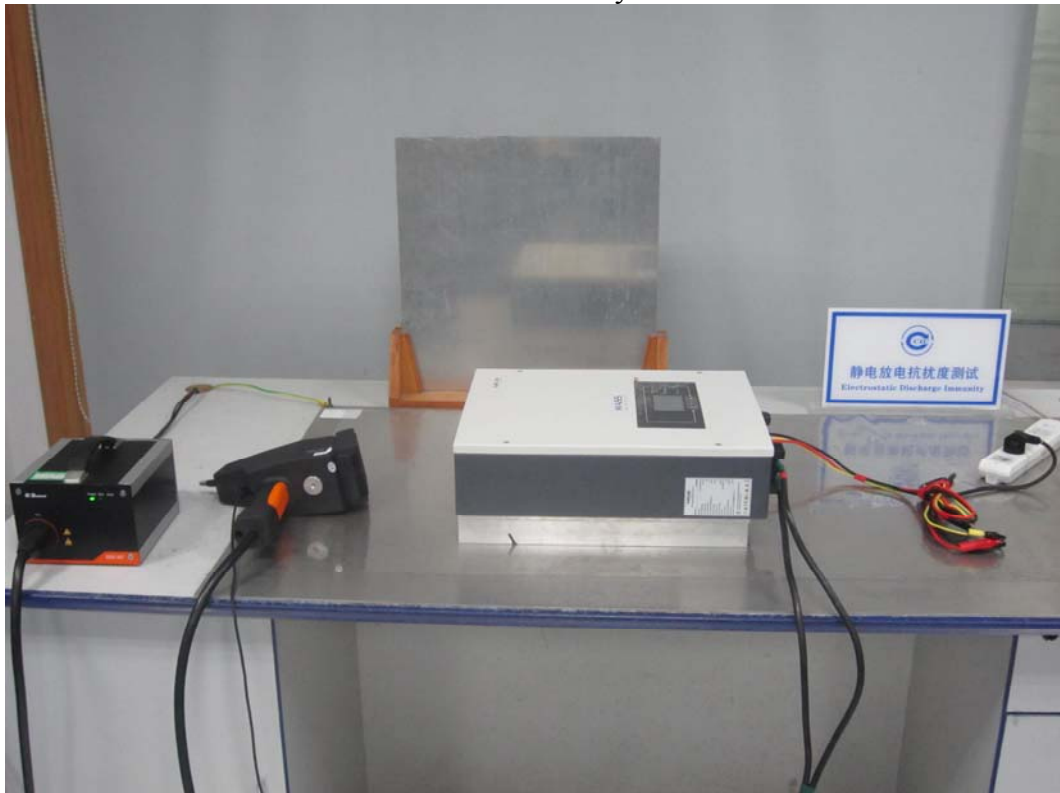

Radiated Immunity

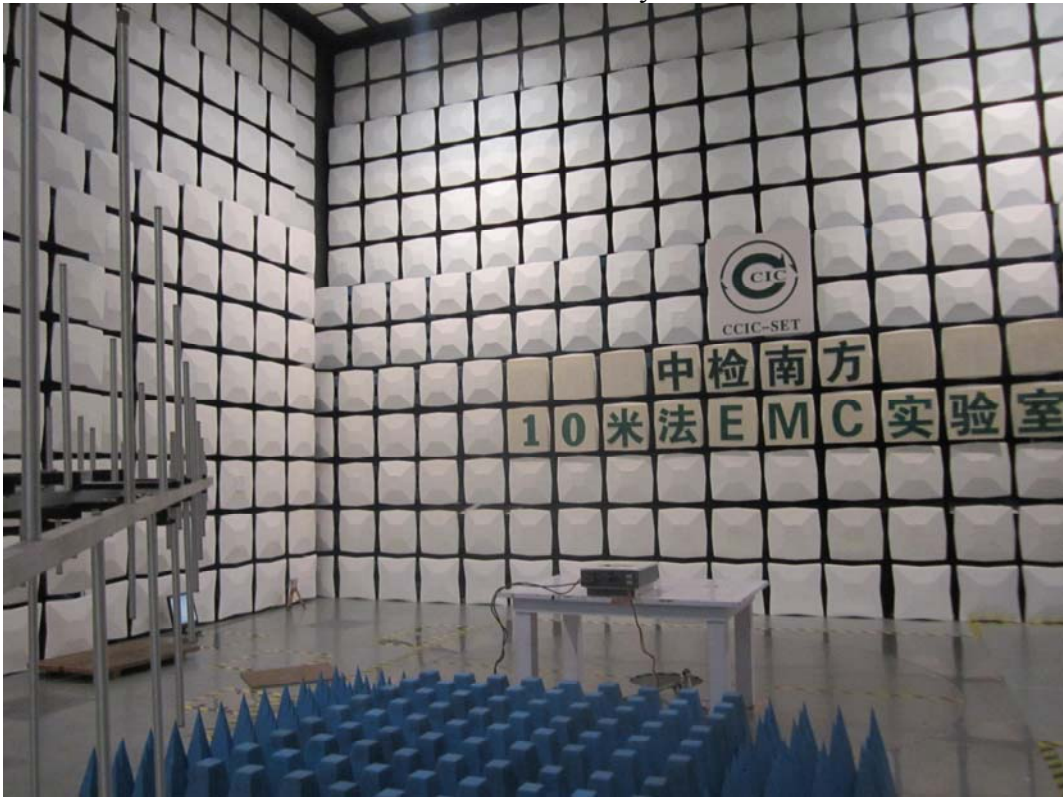

EFT/Surge Immunity



Conducted Immunity

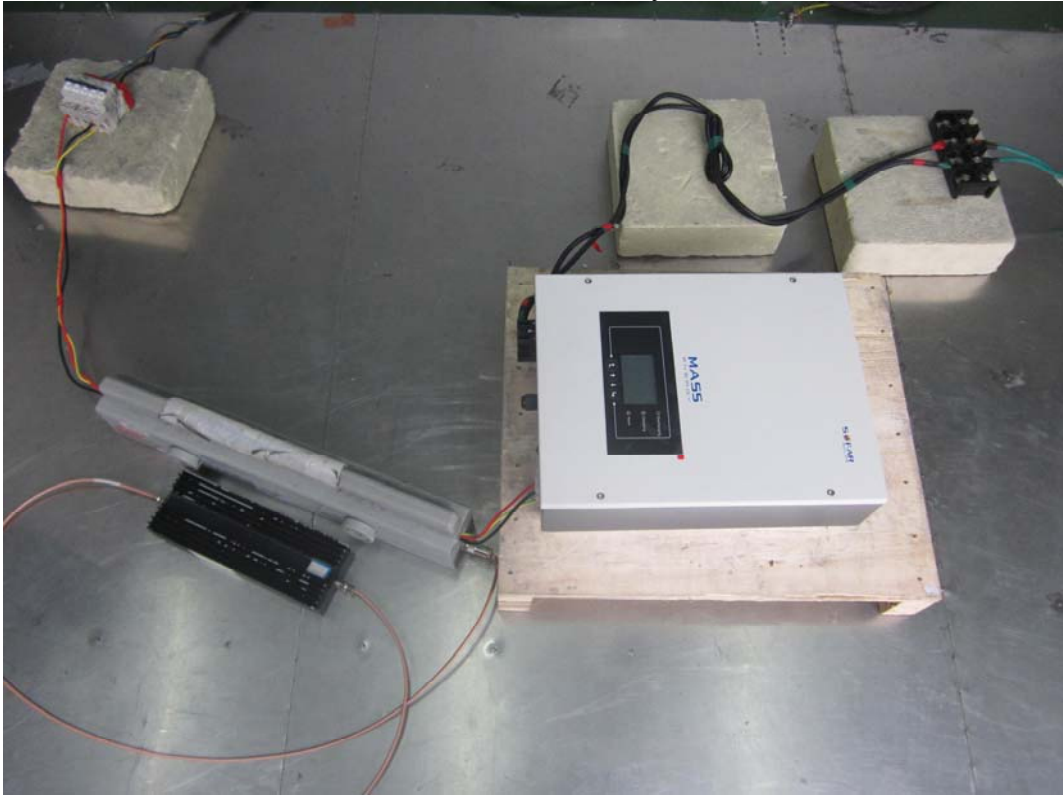

Power Frequency Magnetic Field Immunity

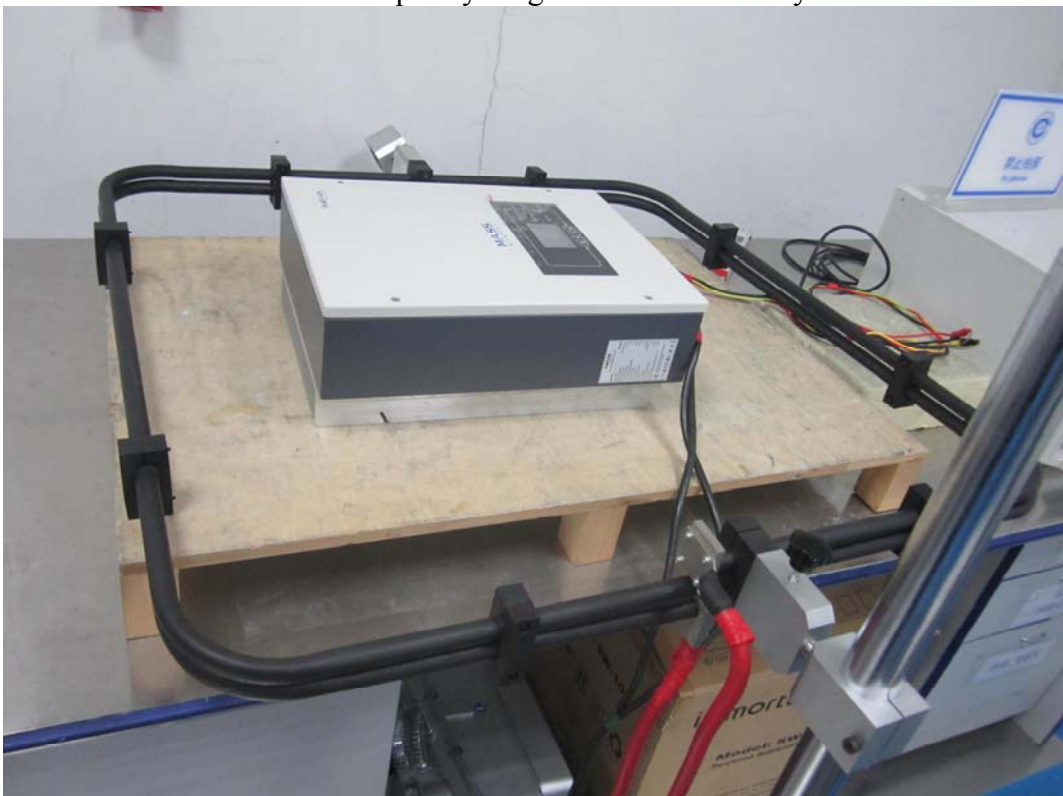

9 Appendix II - Photos of EUT



Overview



Overview



Top view



Heatsink view



Terminal view



Terminal view



Inside view



Inside view

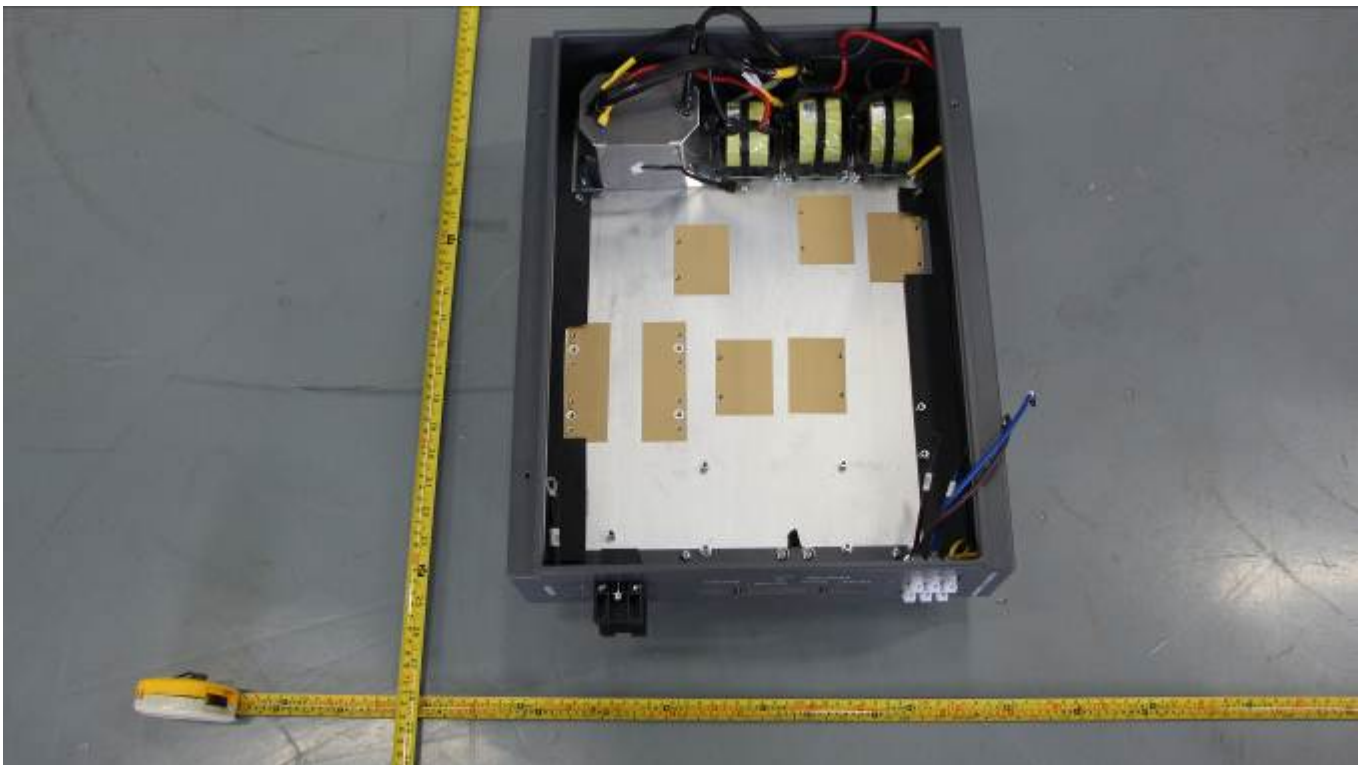

Inside view



Communication board view

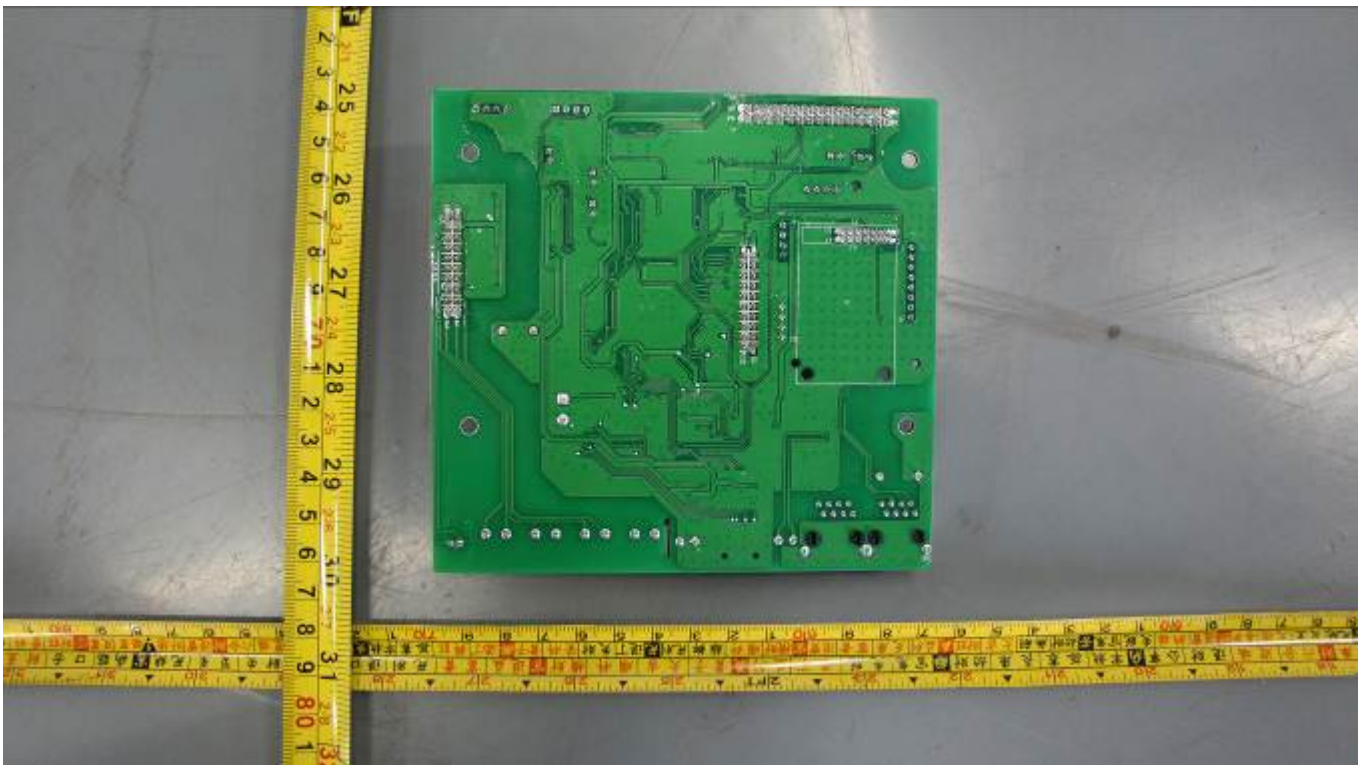

Soldered view

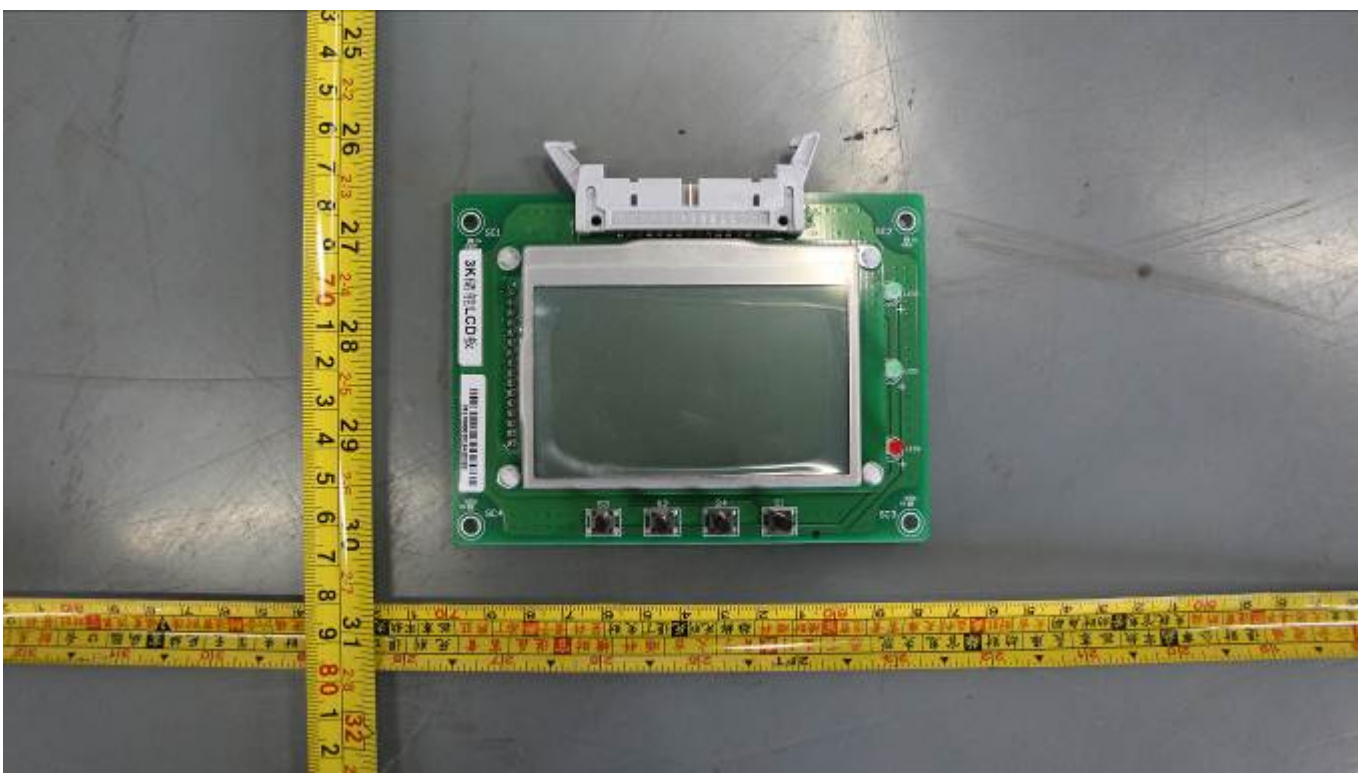

LCD display view

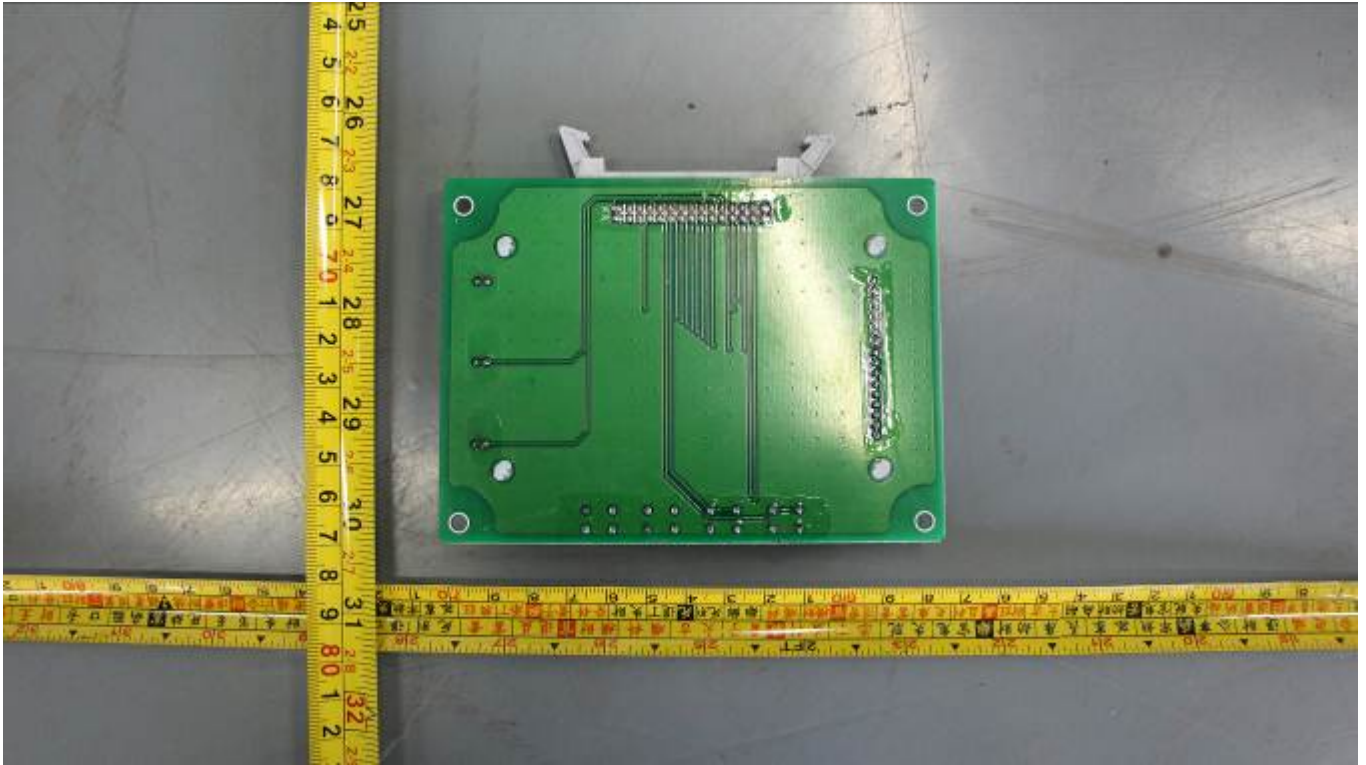

LCD display view

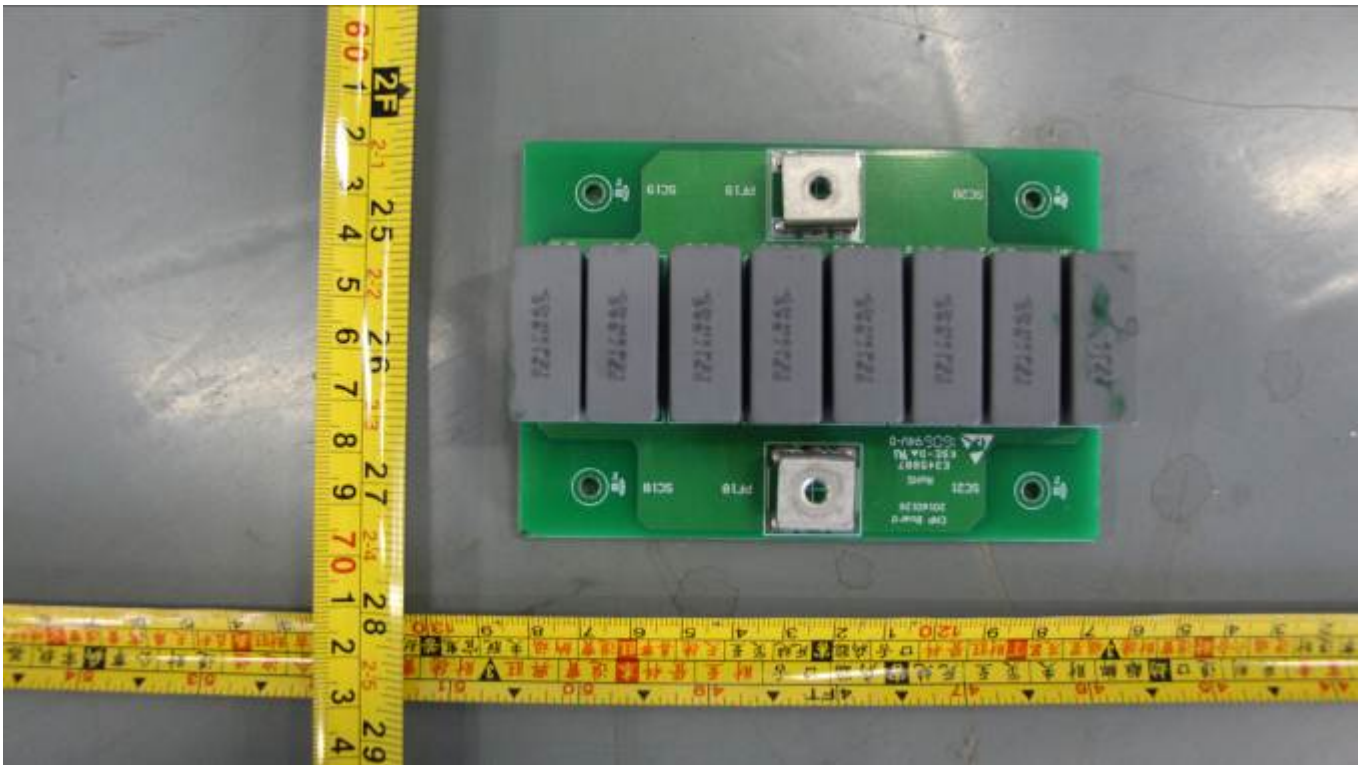

Capacitor A board view

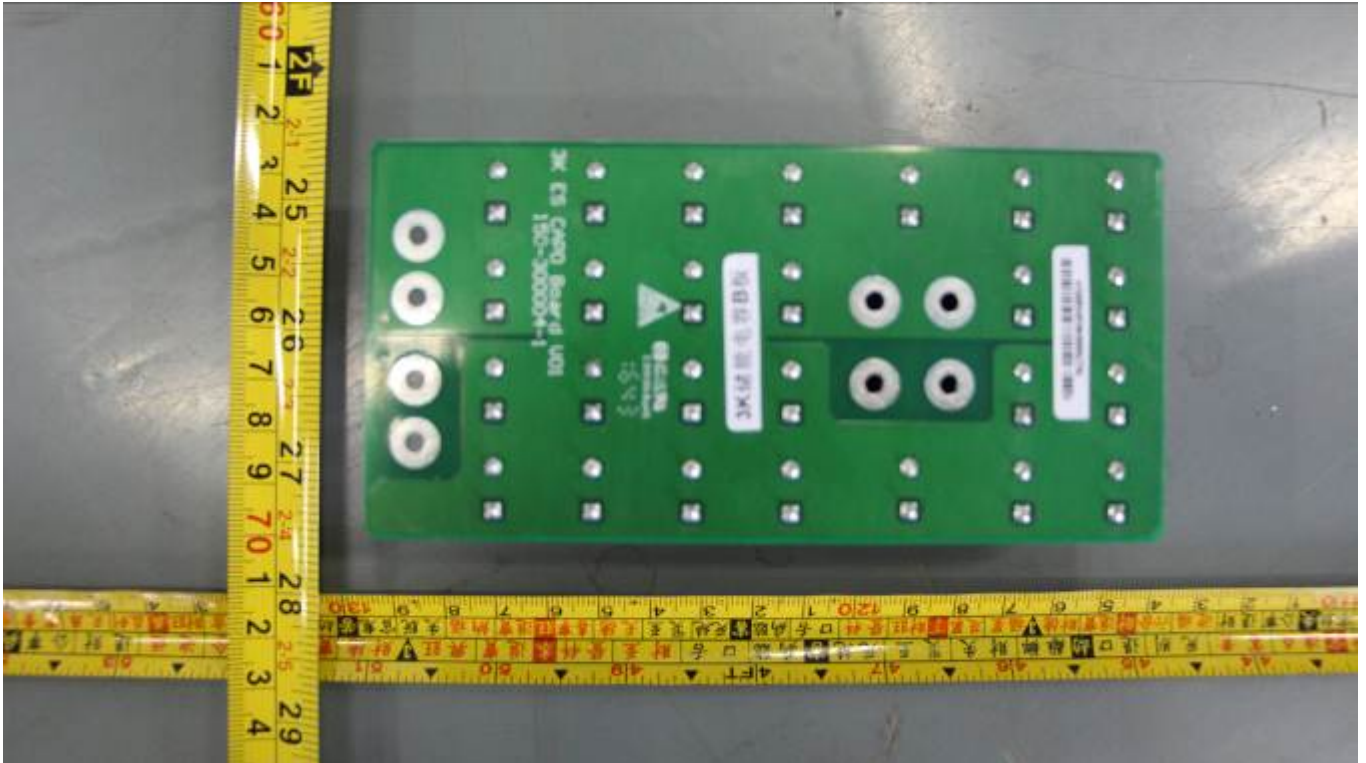

Soldered view



Capacitor B board view

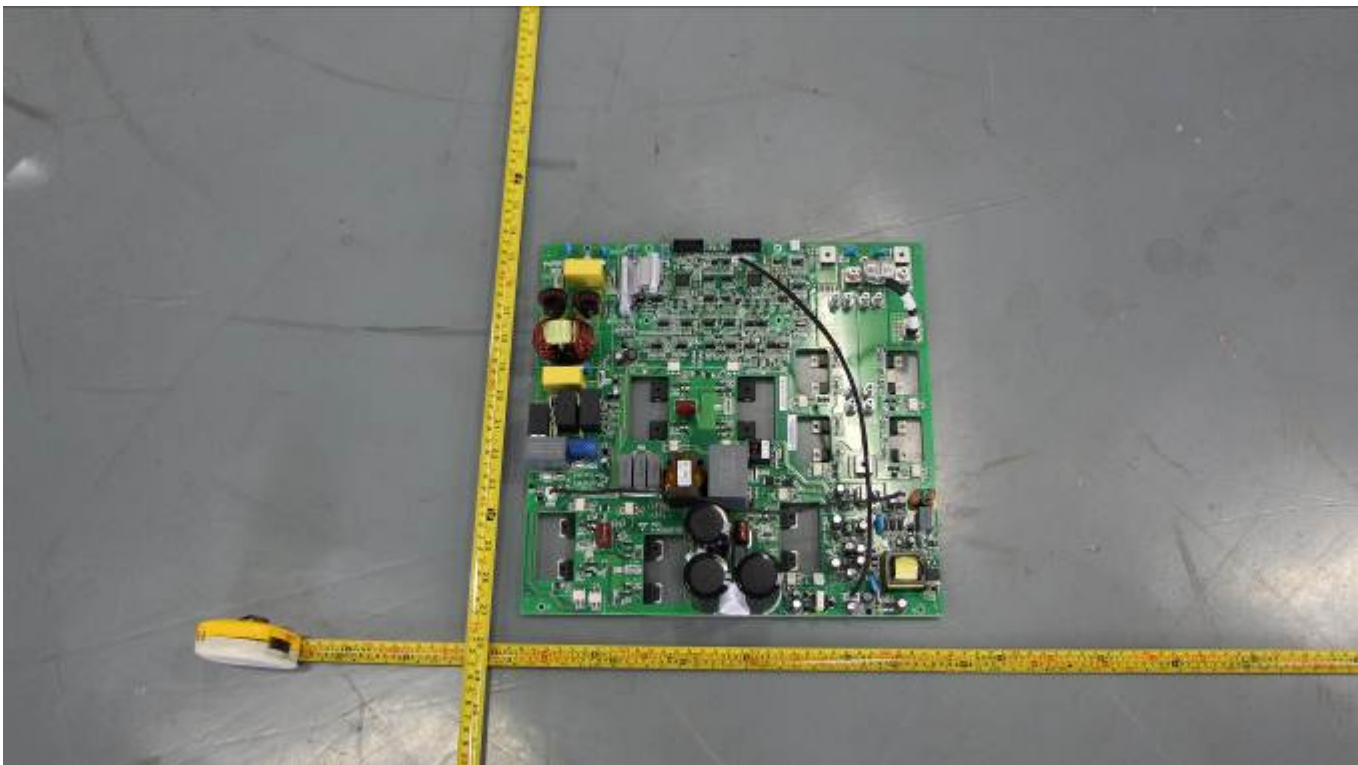

Main board view

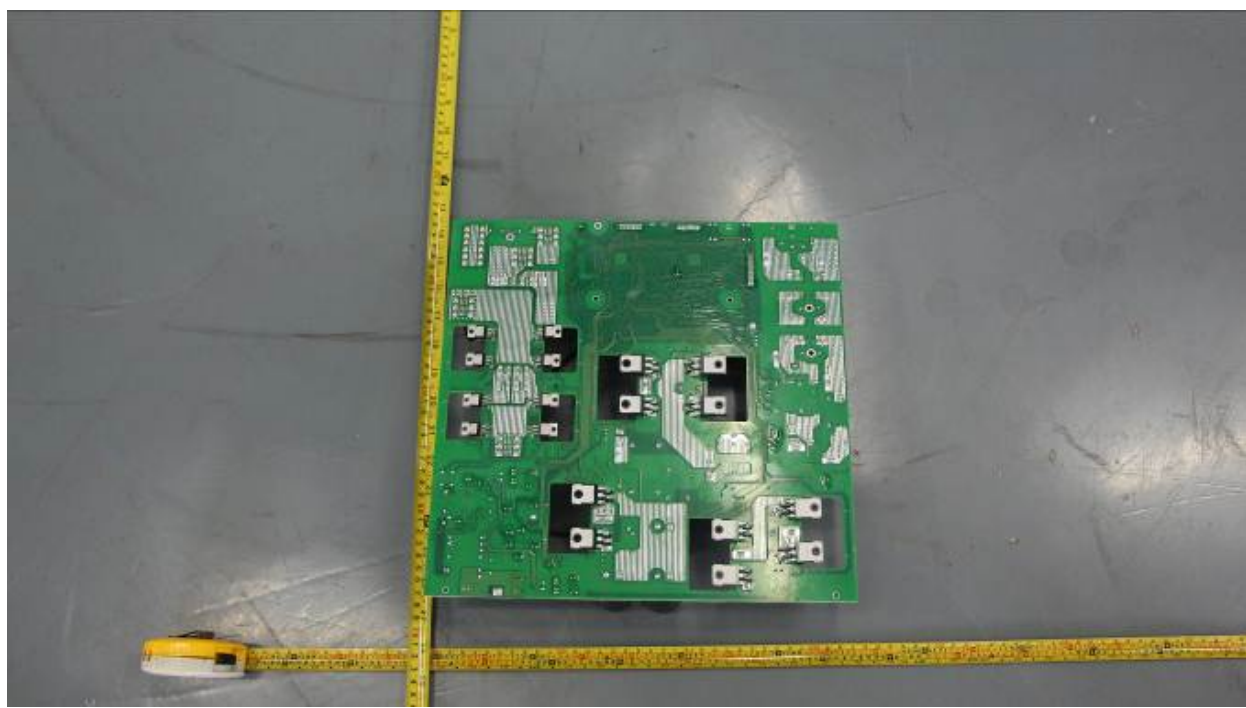

Soldered view